







A Guide to Understanding and Applying Graphics to Common Smooth and Textured Wall Surfaces











Color Keys

-  Smooth and textured surfaces information
-  Smooth surfaces only information
-  Textured surfaces only information

Quick Start Tools

*for the Customer and
3M Sales Representative*

-  **Smooth Indoor Walls**
 - Pre-Installation Worksheet - page 3
 - Customer Checklist - page 4
-  **Textured Indoor and Outdoor Walls**
 - Pre-Installation Worksheet - page 5
 - Customer Checklist - page 6

	Health and Safety	2		Application to SMOOTH Indoor Walls	18
	SMOOTH Indoor Walls Pre-Installation Worksheet	3		Tools and Supplies	18
	SMOOTH Indoor Walls Customer Checklist	4		Substrate Cleaning and Preparation	18
	TEXTURED Indoor or Outdoor Walls Pre-Installation Worksheet	5		Plan Your Layout	18
	TEXTURED Indoor or Outdoor Walls Customer Checklist	6		Liner Removal Technique	19
	Indoor and Outdoor Walls are Different: Smooth or Textured	7		General Application Technique	19
	Common Indoor Wall Applications	7		Application Method - Options for Smooth Walls	19
	Outdoor Wall Applications	7		SMOOTH Indoor Walls - Application Method 1: Vertical	20
	Risk of Damage to Outdoor Application Surfaces	7		SMOOTH Indoor Walls - Application Method 2: Horizontal w/Tape	21
	Wall Textures and Composition: Smooth or Textured	7		SMOOTH Indoor Walls - Application Method 3: Horizontal w/o Tape	22
	Definitions	7		3M Patents	23
	Common Indoor Wall Composition	8		Tools and Supplies	23
	Common Wall Finishes	8		Substrate Cleaning and Preparation	23
	Photos of Textures	8		Graphic Layout	23
	Painted Walls: Paint and Primer Recommendations: Smooth and Textured	10		Heat, Speed of Application, Pressure	24
	Outgassing	10		Application to TEXTURED Walls: Standard Tape Hinge Method	25
	Paint and Primer Application Tips	10		Mosaic Graphic Technique	28
	Film Adhesion Characteristics and Testing: Smooth and Textured	11		Smooth Tile with Mortar Joints Technique	28
	All Walls - Adhesion Characteristics	11		Conforming Film Over Protrusions Technique	28
	SMOOTH Wall Film Adhesion Test	11		Graphic Maintenance, Repair, Removal: Smooth and Textured	30
	Enhancing Film Adhesion	14		Edge Lifting: Causes and Repair	30
	TEXTURED Walls Film Adhesion Test	14		Disposal of Film Liners and Used Graphic Film	30
	General Preparation: Smooth and Textured	17		Cleaning	30
	Who Can Install Graphics?	17		Removal	30
	Know the Film Used in Your Graphic	17		Troubleshooting	31
	Film Processing Conditions	17		Warranty and Limited Remedy	34
	Know What's Behind the Application Surface	17		Technical Service	34
	Application Tapes	17		3M Related Literature	35
	Typical Application Rate for Textured Surfaces	17		Bulletin Change Summary	35
	Dry vs. Wet Application Method	17			

Note

Some tools and processes in this Bulletin are described and claimed in 3M Patents and pending Patent applications.



When handling any chemical products, read the manufacturers' container labels and the Material Safety Data Sheets (MSDS) for important health, safety and environmental information. To obtain MSDS sheets for 3M products go to 3M.com/MSDS, or by mail or in case of an emergency, call 1-800-364-3577 or 1-651-737-6501.

When using any equipment, always follow the manufacturers' instructions for safe operation.



Any activity performed for a long period of time in an awkward position or with a high amount of force is potentially a risk for causing musculoskeletal strain, pain or injury. When applying graphics, follow these practices to improve comfort and avoid injury:

- Alternative your tasks during the application.
- Schedule regular breaks.
- Perform stretches or do exercises to improve circulation.
- Avoid awkward reaching.



Risks of Using Heat Sources

- Read, understand and follow the safety instructions contained in both this 3M Instruction Bulletin as well as the heat-gun manufacturer's manual.
- Wear a heat-resistant glove on the hand(s) holding the applicator.
- Do not use heat sources near solvent mixtures or residues, or in areas where solvent vapors may be present at hazardous levels.
- Never use an open-flame heat source in this process.



Ventilation

Always provide adequate ventilation to remove emissions that may result from the use of heat. Failure to provide adequate ventilation can result in operator exposure.

Important Note!

High Heat May Degrade Foam Rollers and Damage Substrate

High heat directed at the foam may degrade the foam. Always direct the heat toward the film, not the foam roller.

High heat may also damage the substrate: use with caution.

Air Quality Regulations

State Volatile Organic Compound (VOC) regulations may prohibit the use of certain cleaning chemicals with VOC's in graphic arts coatings and printing operations. For example, the California South Coast Air Quality Management District prohibits use of certain solvent-based solutions without a permit and other California AQMD's prohibit use of certain solutions without a permit or a regulatory exemption. Check with your State environmental authorities to determine whether use of this solution may be restricted or prohibited.

- **Pre-Installation Worksheet:** Summarize the type of wall graphics you will be applying.
- **Customer Checklist:** Review and understand the key factors required for a successful applications.

Today's Date	3M Sales Representative											
Customer Information	Installation Site Information											
Contact Name	Business Name											
Business Name	Address											
Address	City/State/Zip											
City/State/Zip	Wall location Check only one. <input type="checkbox"/> Indoor <input type="checkbox"/> Outdoor <i>(Call Tech Service for assistance, 800-328-3908)</i>											
Area Code/Phone												
Graphic Construction/Installation Information												
Print platform Check only one. <input type="checkbox"/> Electrostatic (ES) <input type="checkbox"/> Solvent Piezo Inkjet <input type="checkbox"/> UV Piezo Inkjet <input type="checkbox"/> Screen Print <input type="checkbox"/> Offset	Basic indoor wall construction Check only one. <input type="checkbox"/> Wallboard <input type="checkbox"/> Smooth CMU (concrete block) <input type="checkbox"/> Vinyl wall covering <input type="checkbox"/> Texture, other than already described in this list <i>(If needed, see Worksheet for Textured Surfaces on page 5.)</i> <input type="checkbox"/> Other (describe:) _____											
Graphic sizes List all. List additional on a separate sheet, if needed. 1. _____ square feet 2. _____ square feet 3. _____ square feet 4. _____ square feet 5. _____ square feet 6. _____ square feet	Length of time since wall was constructed or the surface finish (such as paint) applied <input type="checkbox"/> _____ Years _____ Months Is the wall primed and painted? <input type="checkbox"/> No <input type="checkbox"/> Yes, <i>If yes:</i> <table style="width:100%; border:none;"> <tr> <td style="text-align:center;"><i>Check paint type</i></td> <td style="text-align:center;"><i>Check finish type</i></td> </tr> <tr> <td><input type="checkbox"/> Water base</td> <td><input type="checkbox"/> Matte/Eggshell</td> </tr> <tr> <td><input type="checkbox"/> Oil base</td> <td><input type="checkbox"/> Satin</td> </tr> <tr> <td><input type="checkbox"/> Other <i>describe</i></td> <td><input type="checkbox"/> Semi-gloss</td> </tr> <tr> <td>_____</td> <td><input type="checkbox"/> Gloss</td> </tr> </table>		<i>Check paint type</i>	<i>Check finish type</i>	<input type="checkbox"/> Water base	<input type="checkbox"/> Matte/Eggshell	<input type="checkbox"/> Oil base	<input type="checkbox"/> Satin	<input type="checkbox"/> Other <i>describe</i>	<input type="checkbox"/> Semi-gloss	_____	<input type="checkbox"/> Gloss
<i>Check paint type</i>	<i>Check finish type</i>											
<input type="checkbox"/> Water base	<input type="checkbox"/> Matte/Eggshell											
<input type="checkbox"/> Oil base	<input type="checkbox"/> Satin											
<input type="checkbox"/> Other <i>describe</i>	<input type="checkbox"/> Semi-gloss											
_____	<input type="checkbox"/> Gloss											
Length of time graphic will be installed <input type="checkbox"/> Less than 90 days <input type="checkbox"/> 90 days to one year <input type="checkbox"/> One to three years <input type="checkbox"/> Longer than three years	Describe the wall texture Check only one. See page 7. <input type="checkbox"/> SMOOTH. Little or no surface variation. <input type="checkbox"/> UNSMOOTH TEXTURE. Has high spots and low spots. <i>(If this box is checked, see Worksheet for Textured Surfaces on page 5.)</i>											
Graphic exposure conditions Check all that apply. <input type="checkbox"/> Constant temperature and humidity <input type="checkbox"/> Temperature changes <input type="checkbox"/> Direct sun <input type="checkbox"/> Heating or cooling ducts or water source behind or in close proximity <input type="checkbox"/> Graphic may be exposed to physical contact with people, animals or equipment	Test strip identification <input type="checkbox"/> Test Strip IJ3555 (RG 3555, 8655C**) _____ <input type="checkbox"/> Test Strip 8652C** (RG3552C**) _____ <input type="checkbox"/> Test Strip 160-30* (IJ160-10, 8640C**) _____ <input type="checkbox"/> Test Strip 180-10* (IJ180-10, 8620C**) _____ <input type="checkbox"/> Test Strip 3662-10 (8662*) _____ <input type="checkbox"/> Test Strip 1 (Custom) _____	Adhesion value (gm/in) per test _____ _____ _____ _____										
* Includes overlamine 8519 or 8520 **Films with air release channels are not usually recommended for walls Film number in Bold is included, but other numbers listed are equivalent in adhesion												

How to Use the Checklist

This checklist is a companion, not a substitute, for understanding and following all 3M recommendations described in this Instruction Bulletin for applying film to smooth indoor walls.

Failure to use the recommended 3M products and instructions will void any warranty offered in the base film's Product Bulletin for wall applications.

1. Wall Surface Texture

See page 7 for details.

- The required wall texture for successful graphic application and adhesion is SMOOTH, properly primed, painted and cured wallboard that has little or no surface variation. We recommend gypsum board finish level five.
- Too much surface texture allows adhesive contact only with the high points of the wall, which does not provide sufficient contact for a good smooth wall application. Try a film designed for textured surfaces.
- Film laminated with a stiff overlamine, such as graffiti-resistant overlamine, cannot conform to even slight wall texture and must not be used.

2. Wall Surface Preparation and Painting

See page 10 for details.

- Repair any existing wall damage (holes, loose joints, chipped or peeling paint) to return it to like-new condition.
- Clean the wall prior to priming and painting.
- Prime the wall with a primer compatible to the top paint coat. Two coats may be required.
- Paint the wall with a quality, semi-gloss top coat. Do not use matte paint or paint with silicone, graffiti-resistant or texturizing additives.
- Use a short nap (1/4 inch) roller.
- Allow the final coat of paint to dry for at least five days before applying graphics.
- Do not apply graphics to any wall that does not have excellent paint-to-substrate bonding. Do not apply to wallpaper.

3. Perform the Adhesion Test

See page 11 for details.

- Perform an adhesion test on each wall location to which a graphic will be applied.
- Clean an area on the same wall (properly painted and cured) on which the graphic will be applied. Use a clean cloth that has no cleaning agents.
- Use the 3M Wall Test Kit.
- Be aware that the soundness of any wall may vary from spot to spot and no test can assure consistent results over the entire application area.

4. Graphic Application

See page 16 for details.

- Clean the wall immediately prior to applying a graphic.
 - Newly painted walls: use a soft, clean, lint-free cloth to thoroughly remove all dust.
 - Existing walls: wash with 1 ounce of synthetic detergent per gallon of lukewarm water. Avoid soaps or preparations that contain waxes, oils, lotions or conditioners. Allow to dry thoroughly (at least one hour) before proceeding.
- Use a DRY application method.
- Apply the graphic using a stiff nylon brush or a 3M™ Rivet Brush Applicator RBA-1.
- Use straight (non-arcing), overlapping strokes and use the brush to push the film into the texture of the wall to ensure good adhesion.
- To avoid an exposed edge, which are prone to picking and other damage, trim graphic 1/4 inch from inner or outer wall corners.
- ALWAYS finish the graphic by working the brush in small circles around the entire outer 3 inches of the graphic.
- A Troubleshooting table starts on page 31.

5. Limitations and Warranty

- The color and/or shape of underlying graphics may be visible after application of the new graphic. Choose a film with a gray adhesive to increase hiding power for color bleed only.
- Under-cured paint may continue to outgas and cause bubbles in graphics that appears to be well applied right after application.
- The user understands that 3M provides a Basic Product Warranty and only for unused material; no warranty is implied or offered for the adhesion, printed or applied appearance or durability.
- The user understands that 3M does not warrant damage to the substrate or its surface finish caused by removing a graphic from a textured wall. See page 30 for details.

How to Use the Checklist

This checklist is a companion, not a substitute, for understanding and following all 3M recommendations as described in this Instruction Bulletin for applying a graphic to textured indoor or outdoor walls.

No graphic warranty is implied or offered for finished or applied graphics on textured walls.

1. Wall Surface Texture

See page 7 for details.

- Conforming a graphic to textured walls requires adequate heat, special 3M applicator tools and specific techniques.
- 3M's textured surface application tools and techniques may expand the range of suitable substrates and degree of texture for successful application.
- Film laminated with a stiff overlamine, such as graffiti-resistant overlamine may not be compatible with smooth wall installation techniques. However, especially when using film IJ8624, the stiffness of overlamine 8524 enhances most applications.

2. Wall Surface Preparation

See page 23 for details.

- Repair any existing wall damage to return it to like-new condition.
- Brush away loose mortar with a stiff brush.
- For the best results clean all contaminants, including dirt, grease, ketchup, mustard, etc., from the substrate prior to graphic application. Rinse and dry thoroughly.
- If the wall was recently painted, make sure the paint is fully cured (at least 5 days) and dust the wall before graphic application.
- Do not apply a graphic to a wall that does not have an excellent paint/finish-to-substrate bond.

3. Testing Film Adhesion

See pages 14 for details.

- Apply a piece of test film to each different type of textured wall at each location where you will be installing a graphic.
- If feasible, leave the film in place for one week, then return to check for good adhesion and removability before proceeding.
- Be aware that the soundness of any wall may vary from spot to spot and no test can assure consistent results over the entire application area.

4. Graphic Application

See page 23 for general details.

- Use a DRY application method.
- Apply the graphic using a 3M™ Textured Surface Applicator (TSA-1, TSA-2, TSA-3 or TSA-4), or 3M™ Power Grip Magic Pad Rivet Applicator CMP-1 and heat.
- Work at a consistent speed.
- Work straight across the graphic and always to an open edge to allow air bleed. Overlap each pass by 50-75%.
- To avoid an exposed edge, which is prone to picking and other damage, trim graphic 1/4 inch from inner or outer wall corners.
- A Troubleshooting table starts on page 31.

5. Limitations and Warranty

- Under-cured paint may continue to outgas and cause bubbles in graphic that appeared to be well applied right after application.
- Recommended textured surfaces do not include loose sand-textured block.
- Water can accumulate behind the graphic applied to textured outdoor walls, or any walls subjected to excessive moisture. This can cause the graphic to lift and may damage the substrate. There is also the potential to develop mold or mildew on the back, which could be a health concern for some individuals, especially during graphic removal.
- The user understands that 3M provides only a Basic Product Warranty; no warranty is implied or offered for the adhesion, printed or applied appearance or durability or damage to any substrate caused by applying or removing a graphic from a substrate. See the film's Product Bulletin for details.

Indoor and Outdoor Walls are Different: Smooth or Textured

Common Indoor Wall Applications

This Bulletin helps you identify and deal with the *most common smooth or textured indoor walls*. Because architectural construction techniques and finishing options are changing constantly, it is not possible to cover all options, and there may not be a good film choice for every wall surface.

The graphics manufacturer and installer must fully understand the end user's requirements and expectations, and then identify a suitable graphic film through their own testing and approval.

Outdoor Wall Applications

Outdoor wall graphics are subject to a variety of environmental conditions that require different considerations than indoor walls. Applying 3M's textured wall film usually works well for short term outdoor textured walls (less than 30 days) in moderate climates.

CAUTION

Be aware that graphics installed outdoors can develop mold or mildew on top of or behind the graphic, which may be a health concern for some individuals, especially during graphic removal.

Important Note! Risk of Damage to Outdoor Application Surfaces

Freezing and thawing cycles. For a textured masonry wall that has an indoor facing side and an outdoor facing side and no effective moisture barrier, moisture vapor transmission occurs naturally when the indoor surface has a room environment that is warmer and moister than the outdoor surface. When a graphic is applied to the outdoor wall and there are cycles of outdoor freezing and thawing, moisture can be trapped between the wall, resulting in graphic lifting and spalling both within the wall and on the outdoor facing wall. Such damage is unsightly and costly to repair.

Salts passing through masonry may be trapped behind the film. Salt collection on the masonry surface for extended periods may cause staining or discoloration.

Application to loose sand-texture block may result in damage to the surface upon graphic removal.

Always check and follow your local building codes. 3M is not responsible for damage caused by using this product outdoors.

Wall Textures and Composition: Smooth or Textured

Pro's Tip

Understanding each type of wall texture you have to work with helps you select the right film for the job.

Definitions

Application surface. The actual product to which a graphic is applied. This may be the finish—paint, varnish, wallpaper—a composite material or the bare substrate.

Substrate. The supporting structure of a wall, such as wood framing members covered by wallboard, or hard surfaces such as brick, concrete block, stucco, etc.

Texture. This is the visual or tactile feeling that every surface has. Texture can be as smooth as glass to as rough as heavily textured concrete. Whether it is smooth or rough, texture has a significant effect on film choice, ease of application, adhesion and removal. These descriptions provide a way to categorize texture but are subject to interpretation. Use them in combination with the photos of various textures to better understand the texture of your wall surfaces.

- **Smooth texture.** Little or no surface variation. Provides the easiest application since the adhesive can make contact with the entire surface.

Do not use a film *designed specifically for textured surfaces*, such as films 8624 ES and IJ8624, on a smooth surface. Doing so may seriously reduce the quality of the installation.

- **Unsmooth texture.** Has moderate high spots and low spots, ranging from the micro-roughness like fine sandpaper to heavy texture like brick and the macro-roughness of poured concrete with form lines. Extra effort and time consuming application techniques are needed to conform the film to the texture. The following are general texture descriptions. The amount of variation in texture changes throughout any given textured substrate.
 - **Medium unsmooth texture.** Relatively equal distribution of moderately high and low spots.
 - **Heavy unsmooth texture.** Irregular and severe high spots and/or low spots.
 - **Other unsmooth texture.** Brick, concrete block, stucco and tile.

Important Note!
Loose sand-textured block

Do not use this film on substrates with loose surfaces, such as loose sand-textured block. The texture should be more like sandpaper.

Common Indoor Wall Composition

This describes the wall's substrate material.

Brick. A kiln dried, hard clay surfacing material, thicker than tile, for indoor or outdoor walls. Inherently smooth, but may be patterned or textured before firing. Usually has mortar lines.

Concrete. A building material made from a mixture of portland cement, water, fine and coarse particles. Texture can range from smooth to heavy.

Concrete masonry (CMU). A usually hollow building block made with concrete. May be painted or unpainted. Texture is usually medium. Usually has mortar lines.

Mortar (grout) joints. A concrete or composite product used to hold together building materials such as concrete blocks and brick. Such joints can range greatly in width, depth, profile and texture. 3M film for textured surfaces works best if the mortar joints are not more than about 1/8 inch deep, and are flush, concave or V-shaped. Excessively rough texture, excessively steep elevation change—such as Raked, or an undercut profile—such as Weathered or Struck, generally provide challenging applications that may not have the results you desire.

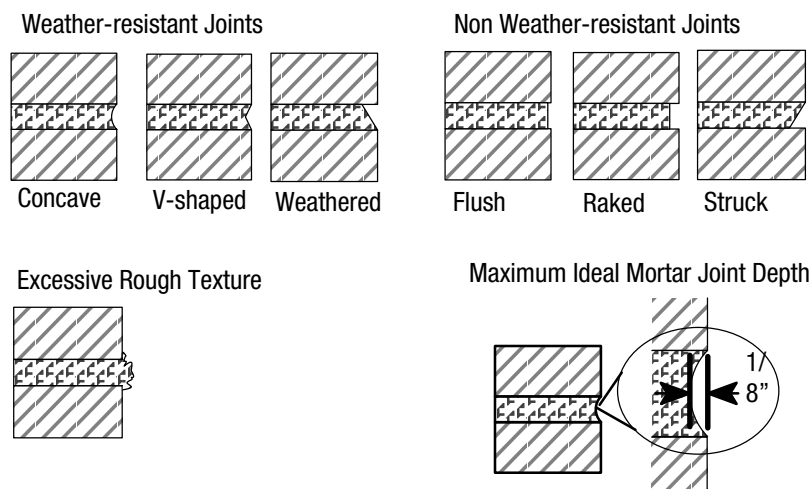

Painted wallboard. Common indoor wall surface, primed, painted and thoroughly dried. Texture varies depending on paint technique.

We recommend gypsum board finish level five wallboard, which is described in the *National Gypsum Construction Guide, 9th Edition, Rev 8/04, page 121*. This product has the highest quality finish. A primer and final coating is recommended. When using graphic films, that final coating should be semi-gloss or enamel paint only.

Stucco. A cement or plaster mixture that is hand or machine applied to indoor or outdoor walls. Our example is between smooth and medium texture, although texture can range from smooth to heavy.

Tile. A kiln dried, thin, hard clay surfacing material for indoor or outdoor walls. May be glazed or unglazed. Texture is usually smooth or a smooth base with an irregular pattern of light texture. Usually has mortar lines.

Common Wall Finishes

Vinyl or paper wallcovering. A thin to heavyweight material used to cover indoor walls. Texture can range from smooth to heavy with little to significant pattern. It may contain plasticizers that migrate to the surface and can cause premature adhesion failure for a graphic applied over it.

NOTE: Application of film designed for textured surfaces to any vinyl or paper wallcovering or wallboard, even those with texture, will probably pull off both the wallcovering and the paper of the wallboard. Use at your own discretion.

Paint. Refer to the Paint and Primer section, page 10.

Glaze, varnish or other surface sealant. A product applied to a surface to provide color, gloss, protection and/or cleanability.

Photos of Textures

Use the previous descriptions and the photos on the following page to determine both the texture and wall composition of common wall surfaces. These characteristics are important in selecting and using the right film as well as determining if the wall is suitable for a successful graphic application.

Painted Wallboard -
Smooth Texture
 Use Smooth Wall Film



Vinyl Wallcovering -
Heavy Unsmooth Texture
 Use Textured Surface Film



Concrete -
Heavy Unsmooth Texture
 Use Textured Surface Film



Painted Wallboard -
Medium Unsmooth Texture
 Use Smooth Wall Film



Vinyl Wallcovering -
Heavy Unsmooth Texture
 Use Textured Surface Film

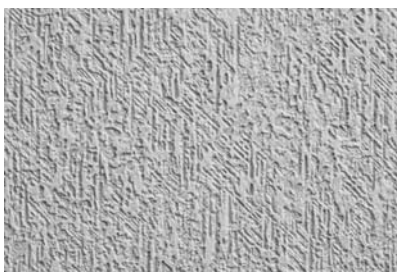

CMU/Concrete Block, Painted/Unpainted
Medium Unsmooth Texture
 Use Textured Surface Film



Painted Wallboard -
Heavy Unsmooth Texture
 Contact Technical Service



Glazed Tile -
Smooth Texture with Mortar Lines
 Contact Technical Service



Medium Unsmooth Texture Brick
 Use Textured Surface Film

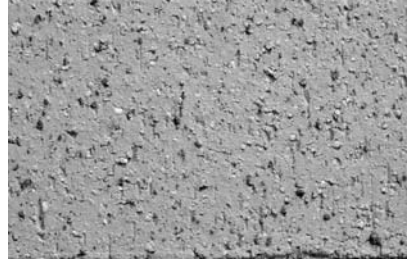

Vinyl Wallcovering -
Smooth Texture
 Use Smooth Wall Film



Poured Concrete -
Smooth Texture
 Use Smooth Wall Film

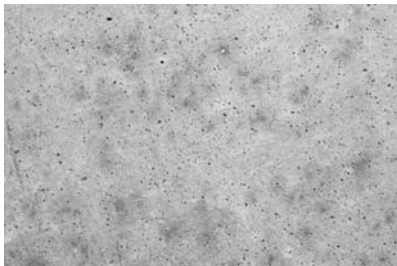

Industrial Stucco -
Medium Unsmooth Texture
 Use Textured Surface Film



Vinyl Wallcovering -
Medium Unsmooth Texture
 Use Textured Surface Film

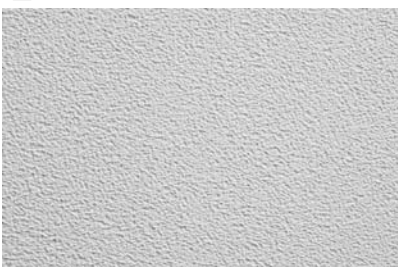

Concrete -
Medium Unsmooth Texture
 Use Textured Surface Film



Painted Walls: Paint and Primer Recommendations: Smooth and Textured



Choosing and using the right primer and paint, and making sure it is well cured, has a significant effect on film adhesion.

Note: The information in this section is appropriate for any wall surface that is painted, whether it is smooth or textured.

When possible, use primer and paint from the same manufacturer; such products are designed to work together. The goal is to achieve a good bond between the substrate, primer and paint.

Laboratory tests on wallboard using Pittsburgh® Paints and Sherwin Williams™ Paints have provided acceptable film adhesion and removability characteristics on sound surfaces, although paint from other manufacturers may be satisfactory. 3M does not endorse any manufacturer.

As a wall finish dries, it releases certain gases until it is fully dried and cured. Applying a graphic before the finish has cured can result in lifting, bubbles and premature graphic failure.

Outgassing

Paint and Primer Application Tips

- Use two coats of primer, if necessary, to get good coverage.
- Use a roller or high pressure spray system to apply primer and paint. These tools provide better coverage than a brush. A short nap (1/4 inch) paint roller generally creates a smooth surface. A long nap roller tends to create a heavier texture.
- Always allow at least 5 days for the final coat of paint to dry before applying graphics to the wall. Graphics applied to insufficiently dried paint may lift or fall off.

Primer	Type of Primer	Considerations	Recommendations
	Oil based, high quality	Good coverage	Kilz® brand primers have shown excellent results
	Tinted primers	May bleed through certain films or be stained by the film's adhesive	Use the highest quality paint to reduce staining or bleed through problems

Paint	Type	Considerations	Recommendations
	Solvent based	Good film adhesion	Perform standard paint/primer adhesion tests
	Latex		
	Powder coated*		
	Urethane		
	Baked enamel paints	Excellent film adhesion and removability	
	Semi gloss	Best universal painted surface	

*Waxes used in powder coatings negatively affect adhesion; always test for acceptable film adhesion.

Paint Additives	Type	Film to Paint Adhesion Characteristics	Recommendations
	Low luster, matte or satin	May inhibit good film adhesion	Determine if matting agents reduce bonding characteristics. Perform both paint/primer tests.
	Silicone or graffiti resistance agents	May inhibit good film adhesion	Perform standard paint/primer adhesion tests
	Migrating particles*	May inhibit good film adhesion, may stain	
	Textured paint	Select a film designed for the amount of texture on your surface. Test surface for acceptable initial adhesion results. For assistance, contact us at 1 800 328 3908.	

*Some particles in a paint's chemistry can migrate over time. Although it is difficult to know if this will be a problem until the graphic is removed, you should be aware of it.

Film Adhesion Characteristics and Testing: Smooth and Textured

All Walls - Adhesion Characteristics

Adhesion is the ability of the film's adhesive to bond to the substrate. The amount of both initial and final adhesion varies with the type of adhesive used on the film, the substrate/surface, and the application temperature and application techniques. The adhesive bond builds with time. Film may never achieve its full bond if the graphic is poorly applied or you are using the wrong film/adhesive combination for the substrate.

- **Adhesion, final.** The maximum amount of bond achieved by a film, usually in 24 to 48 hours after application except in cool temperatures.
- **Adhesion, initial.** The amount of bond needed to hold the graphic during application.
- **Size of graphic.** The larger the graphic, the greater the initial and final adhesive bond to the wall must be to support the weight of the graphic.
- **Imaging method.** This can affect adhesion characteristics. Refer to the film's Product Bulletin for approved methods.
- **Stretching the film.** Film stretched during application may later shrink. This decreases wall adhesion and the graphic may fall off prematurely.

Effect of Overlaminates on Adhesion

Finished graphics must retain some flexibility in order to achieve maximum adhesion. Do not use a stiff or thick overlaminate on the graphic, such as 3M's Scotchgard™ Graphic and Surface Protection Film 8991.

Refer to the base film's Product Bulletin for the recommended graphic protection options. The most common constructions are:

- Smooth walls: One of the recommended films (see page 3) with overlaminate 8519
- Textured walls: Film 8624ES with overlaminate 8519
- Textured walls: Film IJ8624 with overlaminate 8524

SMOOTH Wall Film Adhesion Test



Test Parameters

Testing a film's ability to adhere to a wall is the first step in successful wall applications. It's not a definitive test, but gives you a reasonable idea of the film's suitability.

Contact Technical Service if you need help in performing or evaluating adhesion results.

Purpose of Test

This test is designed to show *initial adhesion capability* of selected 3M films to fairly smooth indoor wall surfaces.

Before Doing the Test

1. Complete the Smooth Indoor Walls Pre-Installation Worksheet and Customer Checklist on pages 3 and 4.
2. Make sure you understand the types of wall surfaces and the variables that influence film adhesion. See page 7.

Test Conditions

The test wall should be a recently cleaned, smooth, semi-gloss painted wallboard that is located in an environmentally-controlled area. For a newly painted wall, the final coat of paint must be dried for at least five days before testing. Always select an inconspicuous area.

Limitations of Test

This test may not detect problems with pre-existing variations in the substrate or poor paint-to-substrate bond. Such problems may result in poor long-term adhesion and damage upon attempted removal of a graphic. 3M cannot be responsible for the results of wall applications.

This test does not guarantee clean graphic removal, even if you are using a removable or changeable film.

- Poor paint-to-substrate bond.
 - This may be visible by signs of peeling, lifting or bubbling of the paint.
 - Sometimes it is not visible, such as if there are multiple layers of paint on the substrate, the bond of one or more layers to another layer may not be adequate, or if the paint is not properly cured.
- Dirty or contaminated surface.

3M Wall Test Kit

- 10 strips of 5 different film/overlamine combinations: each is marked
- Spring scale . Additional scales are available from: Ohaus 29 Hanover Rd., Florham Park, N.J. 07932; 1-800-672-7722, www.ohaus.com
 0-500 grams, part number 8002-MA (less than \$10)
 0-1000 grams, part number 8003-MN
 0-2000 grams, part number 8004-MA
- Scotch-Brite™ High Performance Cleaning Cloth
- Scotch-Brite™ Heavy Duty Scour Pad
- 3M™ Rivet Brush RBA-1 and RBA-3

Making Your Own Film Test Strips

To test a different film, prepare three, 1 inch (± 0.01 inch) by 10 inch strips using the same film and overlamine as your intended graphic. Note this construction on the test strip and on the appropriate Worksheet.

Important Note!

You will be testing THREE samples of the same film and comparing the results.

Procedure

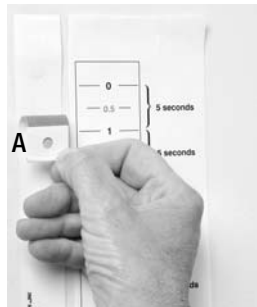
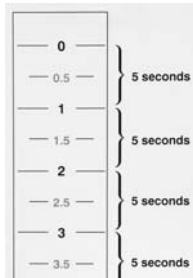

1. Wipe the wall where the test will be conducted. We recommend using a Scotch-Brite cloth. If the wall is more than just dusty, see Substrate Cleaning and Preparation, page 18.
2. Make a measured reference guide. Mark a piece of paper with reference lines at 1/2 inch increments for 0 to 8 inches. Tape it on the cleaned test wall area at eye level.
3. Remove at least two inches of the liner from the punched end of the film strip. Fold and align the two pre-punched holes **A**, adhesive to adhesive, to make a tab on the test strip.
4. Remove the rest of the liner from the film. Use your thumb to adhere the film to the cleaned wall, adjacent to the measured reference guide.
5. Working in the long direction of the test strip and using the rivet brush, use firm pressure and a circular motion to go over the strip three times to firmly adhere it.
6. Repeat steps 3 to 5 for two more test strips of the *same* film, placing them a couple of inches apart.
7. Wait a full 15 minutes before proceeding with the test.
8. **READ THIS STEP THOROUGHLY BEFORE REMOVING THE TEST STRIP.**

Make sure the spring scale is reset to 0. To do this, hold the scale upright (logo at the top) and push or pull the aluminum tab at the top of the tool.

Hold the scale so the gauge faces you.

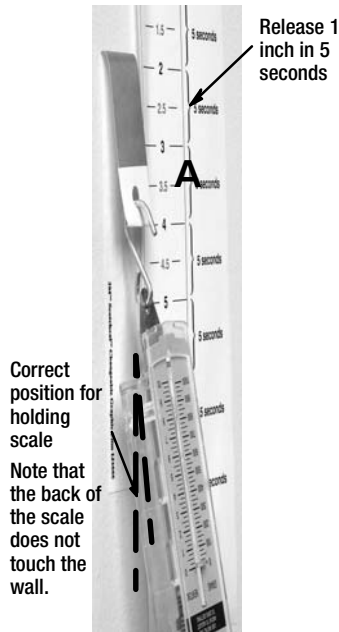

9. Slide the scale's S hook through the punched hole **A** in the test strip.
10. Using the scale, pull down on the test strip at a slight angle, keeping the scale as parallel to the wall as possible without any portion of the scale or your hand contacting the wall during the test.
11. Pull at a steady rate of about 1 inch in 5 seconds, using the measured reference lines as a guide. **DO NOT STOP once you have started.**
12. As you pull off the test strip, take note of:
 - the release characteristics as the film pulls away from the wall;
 - the grams/inch registering on the scale.
13. Repeat for the other test strips.
14. Next, see **Adhesion Test Evaluation**.

Adhesion Test Evaluation

Averaging Test Results

If two or three out of three strips of the same film perform the same way, those are the characteristics by which you judge the suitability of that particular film for your wall.

Interpreting Scale Values

Scale Value	Release Characteristics	Recommendation
0-250 grams/inch	Removes too easily; little or no resistance.	Unacceptable adhesion; try another film; see Enhancing Film Adhesion , page 14, for a possible remedy.
250-450 grams/inch	Smooth, consistent; no jerkiness.	Acceptable adhesion; some film may be successfully removed.
450+ grams/inch	Smooth, consistent; no jerkiness but more difficult to remove; sample may stretch or break.	Acceptable adhesion for a permanent graphic; not recommended for removable graphics.
450+ grams/inch then drops	Pulls inconsistently; seems jerky.	Unacceptable adhesion; try another film.

Factors in Unsatisfactory Test Results

- Test strip removes jerkily, unevenly.
 - Inconsistent or low adhesion value; due to high and low spots in the surface texture, the film's adhesive does not make consistent contact.
 - Cold surface and air temperature, which doesn't allow adhesive to flow or contact as it is designed.
- Test strip pulls paint off wall. If any paint or surface finish is pulled off with the test strip, the paint is not sufficiently bonded to the substrate and graphics should not be applied until the problem is corrected and the wall test is performed again with satisfactory results.
- Wrong film for the job. If the first type of film you tried does not perform acceptably, try a different film and repeat the tests.

Graphics That Require Greater Adhesion Level

- Graphics exposed to indoor environmental changes, such as direct sun light or close proximity heat sources.
- Overlaminated graphics.
- Films that have air release channels, such as in 3M™ Controltac™ Graphic Film with Comply™ Adhesive, which are not recommended for walls.
- Larger graphics.

Enhancing Film Adhesion

There are two ways to improve film adhesion to a finished wall surface if the test strips show less than 250 grams adhesion. Use these techniques only with the agreement of the graphic customer and graphic installer.

1. Construct a secondary smooth surface. The secondary surface is attached to the existing textured surface and the graphic film is applied to the secondary surface.



2. Use a Scotch-Brite™ Heavy Duty Scour Pad to lightly roughen the wall surface. This technique may alter the surface gloss.
 - a. Hold the pad lightly against the wall and wipe it up and down a few times. Then wipe it sideways. Do this for the entire graphic application area.
 - b. Wipe the wall with a clean Scotch-Brite™ High Performance Cleaning Cloth to be sure all dust has been cleaned off.
 - c. Retest the surface to confirm that adhesion has been enhanced.

TEXTURED Walls Film Adhesion Test

Test Parameters

Before Doing the Test

1. Complete the Textured Walls Pre-Installation Worksheet and Customer Checklist on pages 4 and 5.
2. Make sure you understand the types of wall surfaces and the variables that influence film adhesion. See page 7.

Tools

These instructions provide an alternative to using 3M's textured surface applicator tool, TSA 1, when such tools are not available to the person doing the test. 3M testing shows that for judging adhesion and appearance on a small sample, this test is adequate for textured surfaces.

Note: Do not attempt this test using a standard squeegee. You will not be successful.

- Heat resistant gloves
 - 3M™ Power Grip Magic Pad CMP-1 **or** 3M™ Textured Surface Applicator TSA-1, 2, 3 or 4
 - Industrial heat gun with electronic readout, capable of achieving and sustaining 1000°F (538°C). Models you may want to consider are:
 - Steinel HL 2010E LCD Display IntelliTemp Heat Gun*
 - Milwaukee 8988-20 Variable Temperature Heat Gun*
 - Bosch BOS1944LCDK Programmable Heat Gun Kit*
- *Other heat guns may meet your requirements. 3M is not responsible for the performance or suitability of these products.
- At least a 1 square foot sample of film:
 - **For electrostatic printing:** 3M™ Scotchcal™ Graphic Film for Textured Surfaces 8624 ES or 3M™ Controltac™ Graphic Film 8620 ES.
 - **For piezo inkjet printing:** Approximately 1 square foot of film IJ8624. The marketing sheet you may have received from your sales representative is made from film IJ8624 and may be used. Five yard rolls of film IJ8624 are also available.

One inch strips of film IJ180 from the Walls Test Kit may also be applied with the techniques outlined in this section. An adhesion value of more than 3 pounds/lineal inch of film is desirable for extended exterior applications. Use the test on page 12.

Limitations of Test

This test may not detect problems with pre-existing variations in the substrate or poor paint-to-substrate bond. Such problems may result in poor long-term adhesion as well as surface damage upon attempted removal of film. 3M cannot be responsible for the results of wall applications.

This test does not guarantee clean film removal, even if you are using a removable or changeable film.

- Poor paint-to-substrate bond.
 - This may be visible by signs of peeling, lifting or bubbling of the paint.
 - Sometimes it is not visible, such as if there are multiple layers of paint on the substrate, the bond of one or more layers to another layer may not be adequate, or if the paint is not properly cured.
- Dirty or contaminated surface.

Substrate Preparation

Pre-cast concrete material can have an oily surface and be speckled with dust because of the production process. These characteristics inhibit good adhesion.

If you have poor adhesion, use TSP (tri-sodium phosphate) and water according to the manufacturer's instructions, or use 3M™ All Purpose Cleaner and Degreaser, diluted as recommended. Scrub the surface with a brush. Vacuum with a wet-dry vacuum, then allow to dry until it both looks and feels dry to the touch.

Procedure

1. **Read and follow the Health and Safety Information on page 2 of this Bulletin.**
2. Application technique
 - a. Perform the test in an inconspicuous place on each type of substrate you plan to use for each finished graphic.
 - b. Work at a speed that allows the film to be heated enough to make it conformable. Overheating damages the film; under-heating does not permit conformability. A Troubleshooting table starts on page 31.
3. Wear a heat-resistant glove on the hand that holds the applicator tool.

Note: Textured surface applicator TSA-1 and TSA-4 and pad CMP-1 are shown in the following procedures. Applicators TSA-2 or TSA-3 could also be used.

Pro's Tip

To set edges, quickly and lightly pass the heat gun and applicator over the edges of the film to set the edges, but **do not** conform the film; it is critical that air have an escape path during installation. **Edge setting is especially recommended when using overlamine 8524.**

TSA-1 Applicator:
Heat the film just in front of the roller and follow closely with the roller.



4. **If you are using a TSA-1 applicator:**
 - a. Hold the heat gun about 1 inch above and immediately in front of the TSA applicator.
 - b. Start at an outside top corner and work straight across to the other side using this technique: Heat the film directly in front of the roller for about 1 second and then begin following closely with the roller, pushing firmly. Move at a slow, steady pace.
 - c. Roll all the way to the edge.
 - d. Move the roller down about 1-1/2 inches and repeat Step 4 until the film is fully applied.

TSA-4 Two-Handled Applicator:

In a slow consistent movement, heat the film just in front of the roller and follow closely with the roller.



← Direction of Movement for this tool orientation



CMP-1 PAD:

Heat the film, tip the gun away and immediately press the heated film firmly with the pad.

5. If you are using a TSA-4 applicator:

- a. Refer to *Product and Instruction Bulletin TSA & CMP Tools* for complete guidelines.
 - b. Lightly tack the film to the substrate. Use a tapping motion with your fingers or lightly roll it, without heat, using applicator TSA-1 or TSA-4.
 - c. Start at an outside top corner and work straight across to the other side. Moving at a slow, steady pace and using this technique:
Keeping both handles parallel to the application surface and maintaining even pressure, move so the foam heat gun nozzle leads, while staying centered in front of the applicator. Use sufficient pressure to conform the film to the substrate.
 - d. Roll all the way to the edge.
 - e. Move the roller down about 1.5 inches and repeat Step 4 until the film is fully applied.
6. Direct the heat gun toward the top corner of the film. Heat the film until warm, which usually takes only about 2 seconds and immediately begin rolling the film with the applicator TSA-4. The roller should be positioned about 1 inch above the top edge of the film for the first pass.
7. Move continuously at about 2 inches per second and completely past the outer open edge of the film.
8. Move the applicator down 2-½ inches so that the next pass overlaps the previous one by about 1/2 inch. Notice in the photo how the film conformed to the texture during the first pass.

9. If you are using CMP-1 pad:

- a. Heat the film for about 1 second and immediately press the it firmly with the CMP-1 pad for about another second to conform the film around the texture.
 - b. Move to the next section of the film—about 1/2 the width of the pad—heat the film and press firmly with the pad.
 - c. Continue with this procedure across the width of the film and then start a new row, working in the same manner until the film is fully applied.
 - d. Do the next pass across the film by moving down about 1/2 the width of the pad. Repeat Step 9 until the film is fully applied.
10. If the film lifts immediately, the application technique may not have been satisfactory, or the texture is too smooth or too severe. Do not attempt to go over the sample again; try a new one.
11. If possible, leave the film in place for one week, then check for good adhesion and acceptable removal. Note that film 8620 ES typically shows more lifting than film 8624 ES.



Read all instructions before you start: this application may be different than you have done before.

Who Can Install Graphics?

Finished wallboard. Walls and poster-size graphics may be installed by a non-professional installer with relative ease. Two people are recommended to apply most graphics. Notice the two different pairs of hands in the Smooth Indoor Walls Application Methods illustrations, pages 20-30.

Larger graphics are more difficult to handle and align, and multi-panel graphics require skill that is acquired through practice. We recommend contacting a professional graphics installer for assistance with larger graphics.

Textured walls. All graphics applied to textured surfaces must be installed by a 3M-trained installer who has access to the proper tools and has learned the special techniques required for success. Application with a typical squeegee is not effective.

Know the Film Used in Your Graphic

The type of **wall surface** and its **texture** affect how well film adheres, and if required for your job, how easily it may be removed. Be sure the graphics manufacturer tells the installer what film was used, and that the graphics are applied to the surface and texture for which that film is recommended. Refer to the base film's Product Bulletin for recommended application surfaces.

Film Processing Conditions

Processing methods and conditions may affect the film application and performance. Always refer to the film's Product Bulletin for details.

The common methods for processing large format graphics include solvent-based screen printing, electrostatic imaging, and solvent-based piezo ink jet printing. Some recommended films are designed exclusively for one processing method, while other films may be suitable for more than one processing methods.

Know What's Behind the Application Surface

Moisture that has penetrated wallboard will destroy the painted surface when graphics are removed. Remember that, especially in remodeling jobs, wallboard may have been placed over windows, cooling pipes, etc., that may produce moisture that is transferred to the wallboard.

Make sure any block wall in front of equipment such as a pool are properly sealed.

Application Tapes

The use of application tape (commonly called premasking tape) is NOT RECOMMENDED on smooth walls.

If your application absolutely cannot be applied without a premasking tape, be aware that the premasking tape may have a greater adhesive bond to the base film than the base film has to the wall surface. Removing the premasking tape generally lifts the graphic from the wall surface and compromises the adhesive bond of the graphic. If premasking tape is used on smooth surfaces, you must thoroughly rework the entire graphic and all edges after removing it.

Typical Application Rate for Textured Surfaces

Typically, a good application rate is about 50 square feet per hour, so a 4 x 8 foot flat panel takes at least 20-30 minutes.

Dry vs. Wet Application Method

Dry application. All wall films must be applied using a dry application method.

Wet application. This method is NOT RECOMMENDED for walls.

Health and Safety

Please return to page 2 and review all Health and Safety information before proceeding.

Application to **SMOOTH** Indoor Walls

Tools and Supplies

- Scotch™ Masking Tape, 2 inch wide*
- Nylon bristle brush: Use a stiff nylon brush (e.g., household cleaning brush, floor brush) when applying graphics directly to wall surfaces. The brush should be kept to a maximum surface area of 18 square inches or about a 6 inch x 3 inch face.
- Scotch-Brite™ High Performance Cleaning Cloths*
- Scotch-Brite™ Heavy Duty Scour Pad*
- 3M™ Rivet Brush RBA-1* and RBA-3*
- 3M™ Air Release Tool 391X *
- Cutting tools, such as a razor blade with a safety holder
- Industrial heat gun; must be capable of attaining 500° to 750°F (260° to 399°C), or equivalent

*Available from 3M Commercial Graphics Division

Pro's Tip

Using a plastic squeegee is not recommended since it is less effective when applying film to a surface with even slight texture.

Substrate Cleaning and Preparation

Clean the substrate immediately before applying the graphic. Dust and other contaminants can collect quickly on the substrate and prevent the graphic from adhering properly.

- **Contaminants.** If the substrate has any contaminants—dust, dirt, grease, loose paint, food, etc.—the graphic will stick to that rather than the substrate, leading to graphic failure.
- **Edges and corners.** Pay extra attention to cleaning wall edges and corners.
- **Wallboard, except if soiled or greasy.** Wipe down the entire surface with a *clean* lint-free cloth. We recommend Scotch-Brite High Performance Cleaning Cloth. Follow the product directions for cleaning the cloth.
- **Other wall surfaces and greasy painted wallboard.**
 - **For indoor walls where grease and/or oil is present on the substrate:** Wash the substrate with a solution of tri-sodium phosphate (TSP) and lukewarm water. Prepare the solution according to the manufacturer's written instructions.
 - **For most other surfaces:** Wash the substrate with 1 ounce of synthetic detergent per gallon of lukewarm water. Avoid soaps or preparations that contain waxes, oils or lotions. Some window cleaners contain waxes.
 - **Smooth poured concrete walls or concrete block walls** may require power washing or hand washing with a stiff brush and a detergent cleaner followed by a clean water rinse to remove grease and/or exhaust contaminants. Allow the surface to dry thoroughly (at least 24 hours) before applying the graphics. Brush the substrate lightly after drying and immediately before graphic application to remove any dust that may have collected
- **Dry thoroughly.** Use clean, lint-free paper towels. Porous materials absorb moisture and must have time to dry, often for as long as 24 hours.

Plan Your Layout

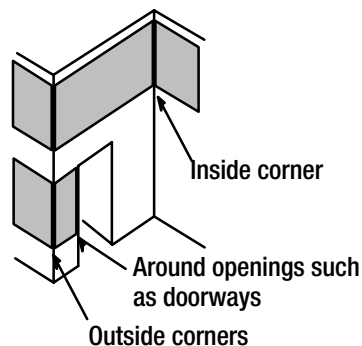

To minimize application problems, which waste time, test your layout by temporarily positioning the graphic on the substrate using masking tape. Plan so the edges are in the least vulnerable place possible

Certain areas of your graphic applications are more prone to damage than others from people or equipment rubbing against the edges. This includes areas around doors, openings such as vents, outside corners of walls and inside corners. To reduce the risk of damage and lifting, trim the graphic 1/8 to 1/4 inch from the edge. After application, rework all edges of the graphic to help ensure good edge adhesion.

Liner Removal Technique

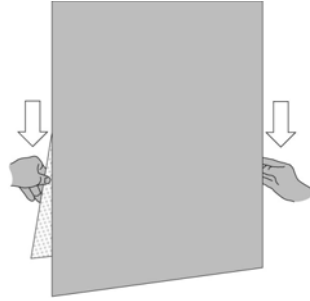

Use two hands when pulling the liner from the film, using care not to stretch the film.

Note: Always remove the liner from the graphic rather than the graphic from the liner.

General Application Technique

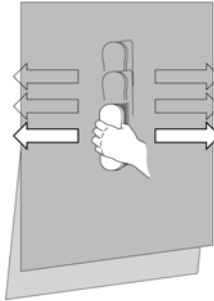

- Pull the brush with your hand, don't push it across the graphic, which stretches the film.
- Move the brush in a straight line-not in an arc.
- Use firm, overlapping brush strokes.
- Re-brush all edges after applying the graphic.

Finishing the Graphic Edges

Usually, the area with the least adhesive bond is the outer few inches of the graphic. Always re-brush the edges in small circular movements before you consider the job done. Always grasp the film as far into graphic as possible without wrinkling the film to avoid transferring body oil and dirt to the adhesive, which can cause adhesion problems.

Application Method Options for Smooth Walls

Read and follow all **General Instructions** before proceeding. Then select the **Application Method** that best matches the orientation of your graphic and printing method.

Graphic Orientation	Printing Method	Application Method
Vertical <i>height greater than width</i>	All printing methods	Method 1 <i>see page 20</i>
Horizontal with tape <i>width greater than height</i>	All printing methods	Method 2 <i>see page 21</i>
Horizontal without tape <i>width greater than height</i>	All printing methods	Method 3 <i>see page 22</i>

SMOOTH Indoor Walls - Application Method 1: Vertical

Orientation: Vertical (*graphic is taller than it is wide*)

Imaging Method: Screen printed, Electrostatically printed, Offset printed

Please review Health and Safety, page 2 and the instructions on pages 18 before proceeding.

1

Wipe the wall, removing dust and any obvious contaminants.

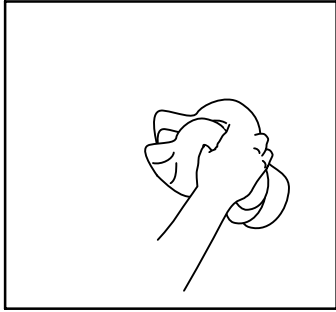

2

Lay the graphic image side down on a flat surface. Pull back about 6 inches of the liner. Sharply crease the liner.

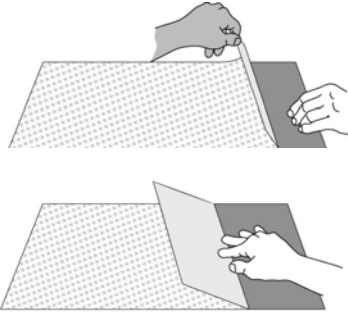

3

Align the graphic on the wall and use finger pressure to tack it in place.

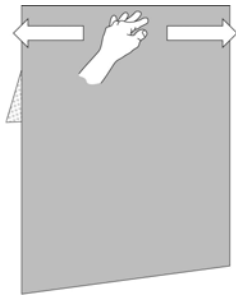

4

Brush from the center to the right edge.

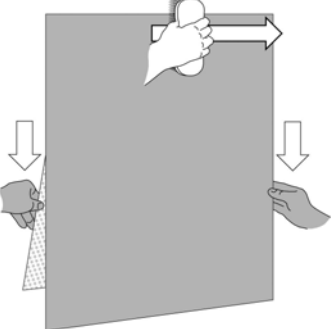

5

Return to the center and brush to the left edge.

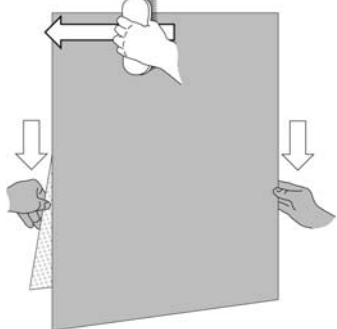

6

Pull the liner down as needed, using two hands.

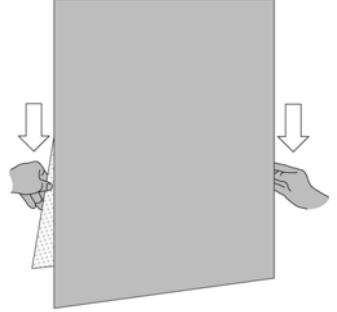

7

Move the brush down a couple of inches and continue stroking right and left, pulling the liner down as needed. Repeat to the bottom.

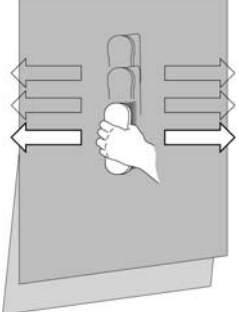

8

Re brush the outer 3 inches of the entire graphic, using a small circular motion, to ensure good edge adhesion.

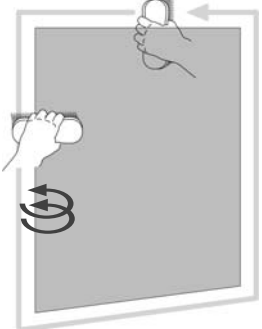

SMOOTH Indoor Walls - Application Method 2: Horizontal w/Tape

Orientation: Horizontal (*graphic is wider than it is tall*)

Imaging Method: Screen printed, Electrostatically printed, Offset printed

Please review Health and Safety, page 2 and the instructions on pages 18 before proceeding.

1

Wipe the wall, removing dust and any obvious contaminants.



2

Align the graphic on the wall, and tape it in place as shown. Place a long strip of masking tape as shown.

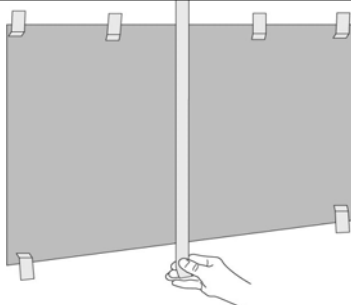

3

Remove the short strips of tape from one side. Pull the film away from the liner all the way to the long strip of tape. Carefully cut off the liner.

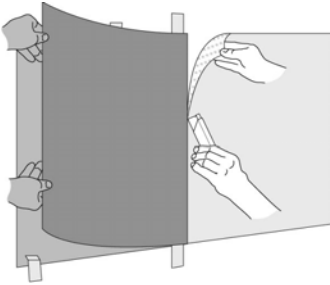

4

Allow the part of the graphic near the center tape to lie against the wall. Gently hold the rest of the graphic away from the wall.

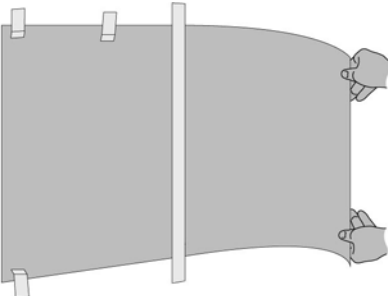

5

Begin at the center and brush up.

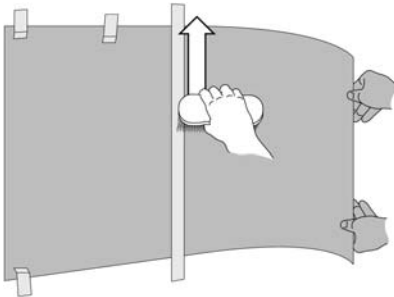

6

Return to the center, and brush down.

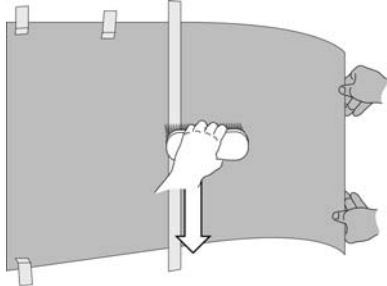

7

Move the brush about two inches left. Repeat Steps 6 and 7 across the graphic, allowing more of the graphic to lay against the wall as you work to the left.

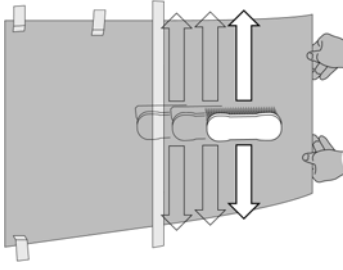

8

Remove the remaining masking tape. Lift the right side of the film and remove the remaining liner.

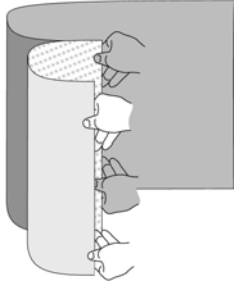

9

Repeat Steps 5, 6, and 7 across the other side of the graphic.

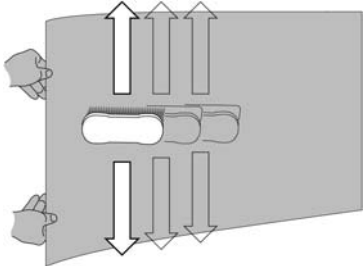

10

Re brush the outer 3 inches of the entire graphic, using a small circular motion, to ensure good edge adhesion.

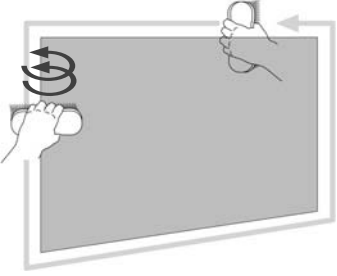

SMOOTH Indoor Walls - Application Method 3: Horizontal w/o Tape

Orientation: Horizontal (*graphic is wider than it is tall*)

Imaging Method: Screen printed, Electrostatically printed, Offset printed

Please review Health and Safety, page 2 and the instructions on pages 18 before proceeding.

1

Wipe the wall, removing dust and any obvious contaminants.



2

Lay the graphic image side down on a flat surface. Pull back about 6 inches of the liner. Sharply crease the liner.

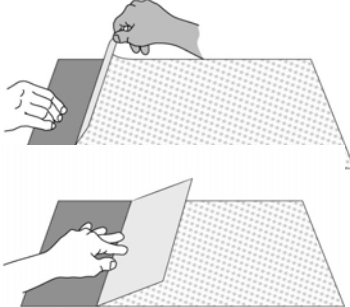

3

Bring the graphic to the wall and align it along the vertical edge. Use finger pressure to tack it in place. **DO NOT USE TAPE**

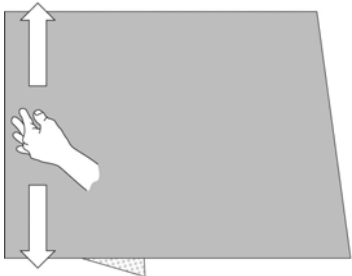

4

Brush from the center to the bottom edge.

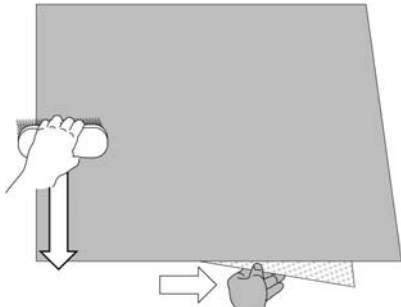

5

Return to the center and brush to the top edge.

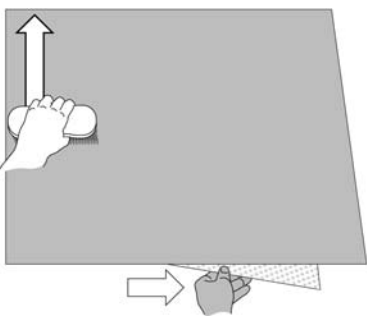

6

Move the brush over a couple of inches and continue stroking center to top, center to bottom, as the helper pulls the liner away from the film.

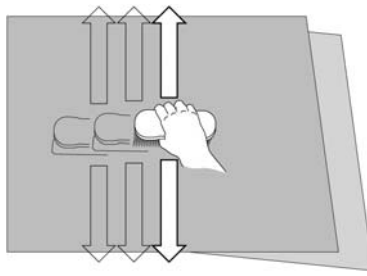

7

Re brush the outer 3 inches of the entire graphic, using a small circular motion, to ensure good edge adhesion.

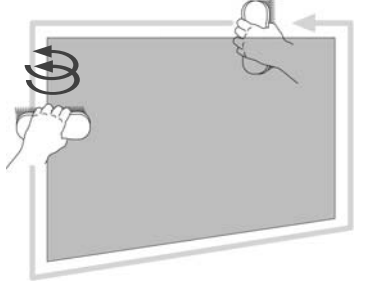

Application to TEXTURED Walls: General Instructions

3M Patents

Some tools and processes in this bulletin are described and claimed in 3M Patents and pending Patent applications.

Important Note! Special Requirements

Application to textured walls requires the use of high heat, 3M's textured surface film and applicator tools and unique application techniques. To help ensure a successful application, please view the 3M DVD, "Textured Walls Application Video", or arrange for a training class, in addition to using this Instruction Bulletin. Contact your local 3M sales representative to assist you with either of these options.

Tools and Supplies

- Scotch™ Masking Tape, 2 inch wide
- Scotch Brite™ High Performance Cleaning Cloths
- 3M™ Air Release Tool 391X
- Heat resistant gloves
- Cutting tools, such as a razor blade with a safety holder
- Industrial heat gun with electronic readout, capable of achieving and sustaining 1000°F (538°C). The following are examples of heat guns that meet the needed criteria.
 - Steinel HL 2010E LCD Display IntelliTemp Heat Gun
 - Milwaukee 8988-20 Variable Temperature Heat Gun
 - Bosch BOS1944LCDK Programmable Heat Gun Kit
- 3M™ Textured Surface Applicator TSA-1 *Large Area Roller*
- 3M™ Textured Surface Applicator TSA-2 *Mortar Joint Roller*
- 3M™ Two-Handled Textured Surface Applicator TSA-4
- 3M™ Power Grip Magic Pad Applicator CMP-1

Storage of Foam Tools

We recommend storing all foam tools neatly in a rigid plastic box when not in use. Storing foam tools carelessly with heavy or sharp objects or exposing them to contaminants can all damage the foam and reduce the effectiveness of the tools.

Pro's Tip

Using a plastic squeegee or a brush is not effective when applying film to a textured surface.

Substrate Cleaning and Preparation

Clean the substrate immediately before applying a graphic for the best adhesion. If the substrate has contaminants—dust, dirt, grease, loose paint, food, etc.—the graphic will stick to that rather than the substrate, leading to graphic failure. Pay extra attention to cleaning wall edges and corners.

Cleaning Most Walls

For the walls in most public facilities, we recommend washing the substrate with the cleaning solution recommended by the building maintenance for the facility. Always avoid soaps or preparations that contain waxes, oils or lotions as they impair graphic adhesion. Dry thoroughly.

Cleaning Concrete Block Walls

Concrete block walls may require power washing or hand washing with a stiff brush and a detergent cleaner followed by a clean water rinse to remove grease or exhaust contaminants. Allow the surface to dry thoroughly (at least 24 hours) before applying the graphics. Brush the substrate lightly immediately before graphic application to remove any dust that may have collected.

Cleaning Loose Mortar

Clean with a stiff bristled brush.

Graphic Layout

Underlying Images

3M's film for textured surfaces has gray adhesive so it provides excellent hiding power for any color or painted images already on the wall. Do not apply this film over other film.

Positioning Graphics

To minimize application problems, test your layout by temporarily positioning the graphic on the substrate using masking tape.

A good application relies on the texture of the wall holding much of the graphic away from the surface while you are positioning the graphic and allows air underneath the graphic a route of escape when heat and pressure are applied. Therefore, when initially positioning the graphic, use your fingers to lightly tack the graphic to the substrate or use the TSA-1 roller to roll on the graphic **without heat**. Then proceed with the heated application.

A few bubbles or wrinkles in the graphic as you first tack it are rarely a problem since you will be heating and technically shrinking the graphic to conform to the texture.

Planning the Layout

- **Outside corner of the graphic.** Try to position the graphic so its edges are in the least vulnerable position possible.
- **Mortar joints.** Refer to the mortar joint information on page 8. Assess the mortar joints for the surface on which you will be working to determine the proper technique for handling them.
 - For most graphics, plan to bridge mortar or grout joints so that at least 1 inch of film extends beyond the mortar joint.
 - For mosaic-style graphics, you may align the first outside corner on the corner of the brick or tile next to the mortar joint.
- **Overlaps.** Plan a 1/2 inch overlap on all multi-panel graphics.
- **Narrower panels** are easier to work with, especially if you are working from a ladder.

Heat, Speed of Application, Pressure

Pro's Tip

Practice on each type of substrate to which you will be applying graphics, and practice to learn the proper speed of application. The biggest problem inexperienced applicators have is moving too quickly.

Important Note! High Heat May Degrade Foam Rollers and Damage Substrate

High heat directed at the foam may degrade the foam. Always direct the heat toward the graphic, not the foam roller.

High heat may also damage the substrate: use with caution.

Insufficient heating of the graphic during application may result in a graphic that looks good immediately following application, but may lift days or weeks later.

Even after you have been trained, we encourage you to perform test installations on a wide variety of painted or sealed and unsealed textured surfaces to master the techniques, improve your efficiency, and give you the confidence to properly estimate jobs.

Through practice, you will learn the best position for holding the heat gun and the right speed. A good starting point is to hold the gun about 1 inch above the graphic and directly in front of the roller. Direct the heat at the graphic, not the roller. Heat a band of the graphic about 1-1/2 to 2 inches wide at a rate of about 2 inches per second. These conditions will vary based on graphic construction thickness and wall texture.



- The role of heat. High heat warms the graphic and adhesive to make it more conformable.
- The role of speed. The graphic must be conformed to the surface texture while it is still warm and pliable. Heat also relaxes lifting stresses within the film, resulting in a better looking and more durable graphic application.
- The role of pressure. Firm, consistent pressure on the roller allows the foam to push the graphic into the texture. Since the film and adhesive cool very quickly when the heat source is moved away, adhesion occurs quickly.

Application to TEXTURED Walls: Standard Tape Hinge Method

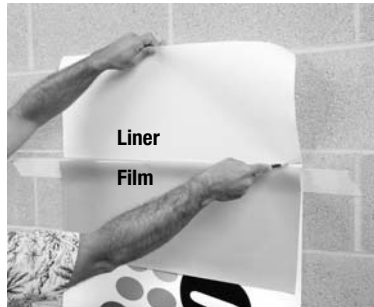

1. Please review Health and Safety, page 2 and the instructions on page 23 before proceeding.
2. Create a tape hinge 10 to 12 inches from the top of the film.
3. Roll the top of the film forward, carefully cut and remove that part of the liner.
4. Gently tack the top few inches of the film to the substrate. Use a tapping motion with your fingers or lightly roll it, without heat, using the TSA-1 roller.

Pro's Tip

Quickly and lightly pass the heat gun and the TSA-1 tool over the edges of the graphic ; but **do not** conform the graphic ; it is critical that air have an escape path during installation. This is especially recommended when using 8524 overlaminate.

Pro's Tip

Always work toward an open edge (as shown in the following photos) through which the trapped air can escape. NEVER work from the edge to the center or from an open edge to a sealed edge, such as at a panel overlap.

The most common application error is moving too fast. Try moving at about 2 inches per second at first and adjust from there. A good application rate is about 50 square feet per hour.



5. Direct the heat gun toward the top corner of the graphic. Heat the film in a 1-1/2 to 2 inch wide band until warm, which usually takes only about 2 seconds and immediately begin rolling the film with the TSA-1 roller. Notice that the roller is positioned about 2 inches above the top edge of the graphic for the first pass.



6. With the roller closely following the heat gun, move continuously at about 2 inches per second and completely past the outer open edge of the graphic.



7. Move the roller down 1.5 inches so that the next pass overlaps the previous one by about 70%. Notice in the photo how the film conforms to the texture during the first pass.



8. After you have applied a few inches of the graphic, take a moment to observe how well the film is conforming to the surface.
 - a. In this example, notice how the film conforms well to the shallow, concave shape of the mortar joints of this wall.

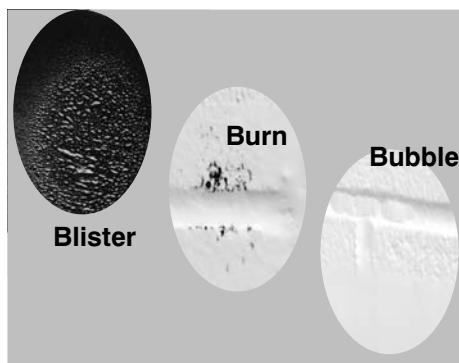

- b. Blisters or burns: do the next pass a little faster.
- c. Bubbles: slow down a little and apply a little more pressure. Also see Step 12 for proper air release techniques when applying graphics to textured surfaces.



9. Remove the tape hinge and expose more adhesive.
 - a. Roll the graphic up, grasp a corner of the liner and gently pull it away from the graphic.



- b. While holding the graphic away from the substrate, evenly pull down about 12 inches of the liner.



- c. Release the graphic and give it a few seconds to recover from the stretching that occurs when you remove the liner.
10. Lightly tack the graphic in the area where the liner was just removed, just as you did in Step 1. Continue working down the graphic as described in the previous steps.
11. Immediately after applying the graphic, inspect the mortar joints. If the lines are very deep and sharp, it will not be possible to conform the graphic to the channel. See mortar joints on page 8.



12. To remove air bubbles.
 - Use an air release tool (never use a knife) to poke a hole near one end and close to the edge of the bubble.
 - Use a finger to push out the air as much as possible.
 - Repeat these steps until the air is pushed out.
 - Rework the area with the heat gun and TSA-1 roller to conform the graphic to the texture.

Mosaic Graphic Technique

Use this technique to create the appearance of an image that is kiln fired onto the block or tile. It is time consuming, but it creates a striking graphic and is also an excellent alternative when the mortar joints are too severe to conform the film into them.

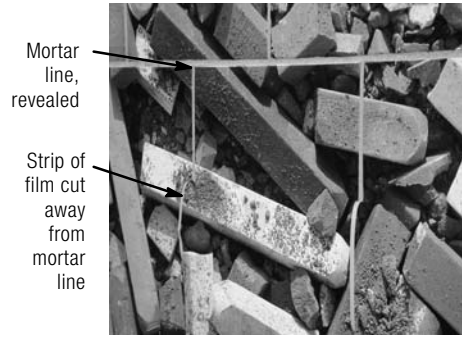

1. Position the graphic so its outer top corner extends about 1/8 inch beyond the outside corner block. Use the film type and application method best suited for the substrate. Don't be concerned about texture, depth or contour of the mortar joints.
2. Apply the film as usual.
3. Then use a very sharp razor in a safety holder to cut most of the graphic out of the mortar joints, leaving about a 1/8 inch margin around each block that you will later heat and conform.

Smooth cut lines are important, which takes planning and practice. The first side of the mortar joint is usually easy to cut smoothly, but the opposite side is more challenging since the first cut releases the tension from the graphic that bridges the mortar line.

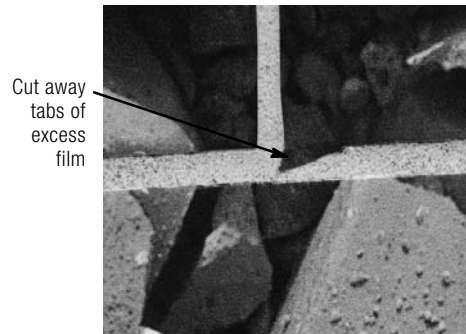

4. Cut away any tabs of film remaining at the corners of the blocks. Leaving any tabs at spectator level may detract from the kiln-fired appearance and invite picking.



5. Heat and roll all edges of each block to ensure good adhesion. The flexibility of the foam will conform the graphic around the edges. Inspect the edges for good adhesion.

Smooth Tile with Mortar Joints Technique

Apply film for textured surfaces to the tile using a standard plastic squeegee without heat. Do not attempt to conform the film to the mortar joints with the squeegee.

Next, using the heat gun and the TSA-1 roller or the CMP-1 pad, heat the graphic at the joints and conform the graphic to the texture. Use the standard textured surface application techniques.

For further assistance with this technique, please contact Technical Service at 1-800-328-3908.

Conforming Film Over Protrusions Technique

Because this film is so flexible, you can conform it over many shapes of hardware, such as anchor bolts in a block wall. The technique is time consuming and requires patience to be successful.

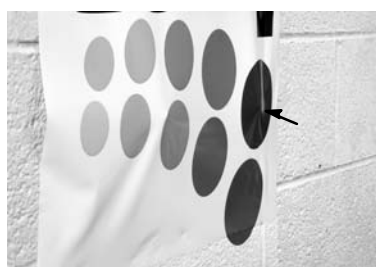

1. Position the graphic and apply it with standard techniques, leaving about a 2 inch margin of the graphic unapplied in a circle around the protrusion.

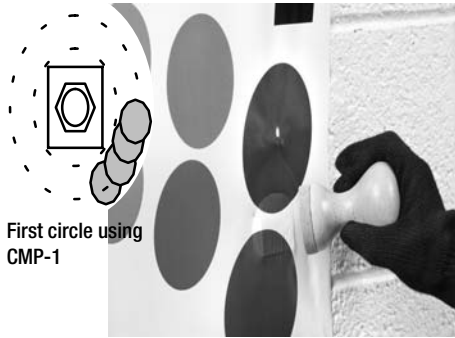

First circle using
CMP-1

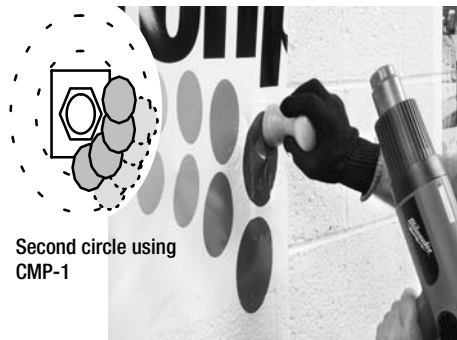

Second circle using
CMP-1

6. In this step you will use the CMP-1 pad and conform the graphic around the protrusion in concentric circles that get smaller as you work toward the protrusion.
 - a. Heat the graphic for about 1 second and immediately press the graphic firmly with the CMP-1 pad for about another second to conform the graphic around the texture.
 - b. Move to the next section of the graphic—about 1/2 the width of the pad—heat the graphic and press firmly with the pad. Move all the way around the protrusion in this manner.
 - c. Use this same technique but move 1/2 pad width closer to the protrusion and continue around the protrusion.

7. When the graphic is well conformed around the outer edges of the protrusion, some air will be trapped in a bubble around the protrusion.
 - a. Puncture the graphic in an unobtrusive spot and push the air out.
 - b. Heat the graphic until it is conformable.
 - c. Remove the heat and immediately use a gloved hand to conform the graphic around the protrusion.

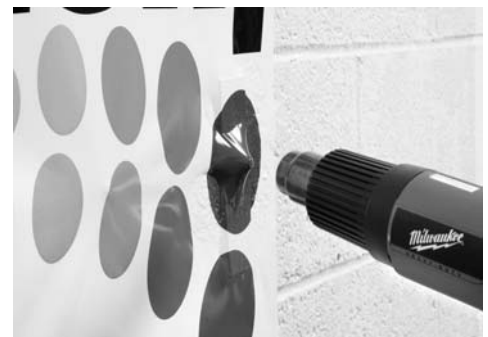
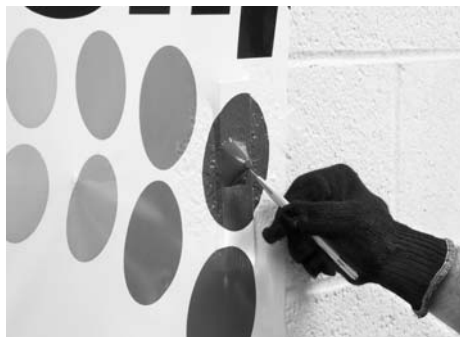

Completed view

Edge Lifting: Causes and Repair

Edge lifting is generally caused by inadequate adhesion. It may be due to using the wrong film, contaminants on the substrate, poor edge finishing during installation, abrasion by people or equipment, or environment. Reattaching lifted edges can extend the life of the graphic and improve appearance, but these techniques are aggressive and will probably damage the application surface.

- **Option 1:** Apply a strip of two-sided 3M™ Transfer Adhesive 950 (5 mil thick, 1/2" x 60 yard roll) to the back side of the graphic, close to the edge. Use a brush around the outer edges as shown in the last illustration of any of the illustrated Application Methods.
- **Option 2:** Use mechanical fasteners such as staples.

Disposal of Film Liners and Used Graphic Film

These products may be incinerated or may also be safely disposed of in a landfill per U.S. Environmental Protection Agency guidelines.

Cleaning

Refer to Instruction Bulletin 6.5 for detailed cleaning guidelines.

Note: The term "paint" refers to any surface finish that may have been applied to the substrate.

Removal

Removing a graphic can damage the wall's finish, surface or substrate. You can reduce the risk of removal damage by following all recommendations and procedures in this Instruction Bulletin.



Important Note!

Before selecting a film, be sure you understand the customer's requirements for removal.

Due to the great variety of wall surfaces, there is no guarantee against damage free graphic removal. Experience suggests that films that adhere to substrates having sound surface characteristics, including excellent bond between the surface finish and substrate, and are within the adhesion range of 250-450 grams/inch, should provide reasonable removal characteristics. Typically, the greater the adhesion level, the greater the risk for removal damage.

Determining Graphic Removability

Changeable or Removable Films

Some 3M films used for smooth indoor wall graphics have a removable adhesive that improves removability within a stated durability period and conditions and when removed as directed.

Permanent Films

Many films that are suitable for application to a wall have a permanent adhesive, may be very difficult to remove from a smooth wall surface and may result in surface damage.

Although 3M™ Scotchcal™ Graphic Film for Textured Surfaces 8624 ES and IJ8624 have a permanent adhesive, the films generally have good removal characteristics due to the textures on which they are used. The greatest risk in removal is:

- Loose mortar may be pulled off.
- Poorly bonded paint or any textured finish may be damaged.
- Film exposed outdoors for a long time may be difficult to remove cleanly.

Ease of Removal

This depends on factors such as film properties, type of surface and substrate, initial adhesion test values, graphic imaging method and ambient exposure characteristics. However, wall texture is the most important factor in removability.

Hidden Problems

Cuts in the substrate or moisture that has penetrated wallboard will destroy a painted surface when graphics are removed and may damage the substrate. Common moisture problems that can transfer moisture to the substrate include wallboard placed over windows, cooling pipes, etc.

Freezing and Thawing Cycles

For a textured masonry wall that has both an indoor facing side and an outdoor facing side and no effective moisture barrier, moisture vapor transmission occurs naturally when the indoor surface has a room environment that is warmer and moister than the outdoor surface. When a graphic is applied to the outdoor wall and there are cycles of outdoor freezing and thawing, moisture can be trapped between the wall and result in graphic lifting, as well as in spalling both within the wall and on the outdoor facing wall. Such damage can be unsightly and costly to repair.

Basic Removal Techniques

- Removing wall graphics is significantly different than removing graphics from semi trailers and vehicles.
- Using two hands, start at the top of the graphic and pull it down slowly at a consistent 120 to 180 degree angle.
- If graphic is difficult to remove, cutting it into strips may ease the removal process. Do not cut the substrate.
- Do NOT use chemicals for indoor wall graphic removals.
- Heat may be helpful if the substrate is not wallboard. The heat softens the adhesive, which reduces the pull off force, and it makes the film more elastic, reducing the tendency to tear.
- If the substrate appears stained after graphic removal, it is usually the result of one of the following: poor quality paint, exposure to heat and light, migrating particles in the paint, and adhesive residue.
- See Instruction Bulletin 6.5 for more details.

Troubleshooting



Ensure that walls are in good condition before applying graphics. This generally reduces application time while improving graphic appearance, and if applicable, removal characteristics.

Review all troubleshooting before deciding on a course of action.

Problem	Details/Causes	Recommended Solutions
Pre-Installation Problems - All Walls		
1	Potentially unsound walls or substructures.	Evidence of a loose, inconsistent or damaged surface finish, loose paint, mixed surface finishes, abrasion, gouges, etc.
2		Concrete substrate is below grade and not sealed.
3		Any substrate that may have moisture behind it.
4		Extremely rough and/or loose/flakey mortar.
4		Loosely bonded sand surface.
5	Unclean substrate.	Surface contamination such as dust, dirt, grease, food, vehicle exhaust or cleaning products.
Tool Problems - TEXTURED Walls Only		
6	Foam on the tool is falling apart.	Foam has been exposed to too much heat.
7		Foam tools have been improperly stored.
8		Tool is simply worn out.
Installation Problems - All Walls		
9	Film does not adhere well.	The texture of the substrate is not well suited to the film being used.
10		Repaired walls areas were not properly sealed, primed, painted or cured.
11	Film for textured surfaces does not conform in mortar joints.	Mortar joint has too much texture or too severe a profile for success.

Problem	Details/Causes	Recommended Solutions
Installation Problems - TEXTURED Walls Only		
12	Film melts or blisters.	Heat was concentrated too long in one area. <ul style="list-style-type: none"> • Move the gun and tool a little more quickly. • Decrease heat 50° to 100°F.
13	Film is not conforming well to texture.	Film was not heated enough. <ul style="list-style-type: none"> • Increase the heat. • Slow down a little. • Use a little more pressure on the tool. NOTE: Most textured substrates do not hold heat well, and cause the film to cool more quickly than you might expect.
14	Film pops up from mortar joints.	The mortar joint was too deep.
15		The mortar joint was too sharp.
16		The film was not heated properly and worked well into the mortar joints.
17		Film does not want to conform to the texture.
18		Film lifts excessively from textured in areas where there are large temperature variations.
19		Printed film was not adequately dried prior to installation.
20		Wrong film was used.
21	Film lifts over caulked joints.	Film will not stick to silicone caulk.
22	Film "pops" and leaks adhesive.	Printed film was not adequately dried prior to installation.
23	Film folds onto itself at the edges.	Film has not been sufficiently set at the edges.
24	Large bubbles appear behind the film.	Film was not fully adhered during first pass of the tool.
25		Mortar line is excessively deep.
26		Adhesive channels through which air escapes were sealed before film was fully applied.
27	Large bubbles appear behind the film.	Film was applied to flat, glazed tile.
28	Bubbling and poor adhesion.	Film was applied to a damp substrate
29	Difficulty wrapping textured columns.	Wrong product.
30		Graphic is not level.
31		Exposing too much adhesive at one time.
32	Printed film is gummy.	Ink is not thoroughly dried before application.
33	Film develops wrinkles during application.	Film is too flexible. <ul style="list-style-type: none"> • Apply overlaminate 8524 to film IJ8524 for a stiffer graphic. • If not using an overlaminate, apply 3M™ Premasking Tape SCPM-19 to stiffen the graphic. Be sure to pull it off at a 180 degree angle after the film has been tacked to the substrate and prior to conforming to the textured wall.

Problem	Details/Causes	Recommended Solutions
Installation Problems - Textured Walls Only		
34	Film is tunneling off the liner.	Poor lamination of overlaminates. <ul style="list-style-type: none"> Set the minimum pressure needed and unwind tension to obtain good lamination. This helps reduce the chance of the overlaminates tunneling as it is applied to the base film. However, tunneling will disappear when the graphic is applied with heat and pressure to a textured surface. If possible, do not wind the overlaminated graphics onto a core, or use as large a core as possible (more than 6 inches diameter). Using proper application techniques, the finished application generally turns out well anyway.
35	Poor printed graphic quality.	Used UV-curable inks.
36		Used unapproved inks.
37	Cold weather installation.	Film has poor adhesion. <p>Temperatures below about 40°F do not allow the adhesive to flow sufficiently, even when heated, and heating the substrate may release trapped moisture. Two ways to test are:</p> <ul style="list-style-type: none"> Aim the heat gun at the substrate and see if the substrate appears to sweat. If it does, do not apply until the temperature is warmer. Finger tack the film to the substrate. If it does not adhere, it is too cold to proceed.
38		Film is cracking.
39	Hot weather installation.	Film is too sticky to apply.
Post-Installation Problems - All Walls		
40	Edges of graphic lift prematurely.	Poor application technique, inappropriate substrate, or wrong tools.
41	Much of graphic lifts or falls off prematurely.	Poor initial bond of paint/finish to substrate.
42		Under-cured paint/finish.
43		Moisture behind wallboard causing wallboard paper to release.
44	The surface, or its paint, finish or wallcovering is damaged during graphic removal.	Poor bond of paint, finish or wallcovering to substrate.
45		Poor removal technique.
46	The surface, or its paint, finish or wallcovering is damaged during graphic removal.	Cuts made to the graphic during the installation penetrated both the film and substrate.
47		Surface is poured concrete.
48	Film is bubbling and/or popping off the substrate the next day.	Roller was moved too quickly.
49		Film was not heated enough.
50		Attempted to rework an area that didn't go down well at first.
51		Film was not heated evenly.
52		Not enough heat was used.
53		Wrong film or overlaminates used.

Problem	Details/Causes	Recommended Solutions
Post-Installation Problems - Textured Walls Only		
54	Film is bubbling and/or popping off the substrate the next day.	Too hot an environment.
55		Texture is too severe.
56		Application performed too quickly.
57		The substrate has poor cohesive strength.
58	Outdoor graphic appearance has degraded.	Graphic has been up too long.
59		Graphic exposed to excessive heat.
60	Outdoor graphic caused substrate damage.	Graphic subjected to freeze-thaw cycles.
Removal Problems - All Walls		
61	Difficult removal.	Film is too cold.
62		No overlamine on film.
63	Substrate is being damaged as film is removed.	Film is too cold.

Warranty and Limited Remedy

The information contained and techniques described herein are believed to be reliable, but 3M makes no warranties, express or implied, including but not limited to any implied warranty of merchantability or fitness for a particular purpose. 3M shall not be liable for any loss or damages, whether direct, indirect, special, incidental or consequential, in any way related to the techniques or information described herein.

The 3M Graphics Market Center Warranty Brochure, in conjunction with the applicable film Product Bulletin, provide the details to any warranty offered for the 3M graphic products described in this Bulletin.

Technical Service

For assistance in reviewing your film qualification test results. Fax or mail the completed worksheet to:

Attn: Wall Surface Evaluation, Technical Service
3M Center, Building 207-1W-022, St. Paul, MN 55114-1000

For other questions regarding wall applications, call us at 1-800-328-3908.

3M Related Literature

Before starting any job, be sure you have the most current Product and Instruction Bulletins.

The information in 3M Product and Instruction Bulletins is subject to change. Current Bulletins are available at 3Mgraphics.com. The techniques described in these Bulletins are required when applying a 3M warranted graphic, but are also practical recommendations when using promotional materials for non-warranted graphics. Additional Bulletins may be needed as indicated in the 3M Related Literature section of other 3M components you use.

Bulletin types: PB = Product Bulletin; PB-IB = Product & Instruction Bulletin; IB = Instruction Bulletin

Subject	Type	Bulletin No.
3M™ Controltac™ Film Series 160 or Film with Comply™ Adhesive Series 160C	PB	160/160C
3M™ Controltac™ Graphic Film Series 180 or Film with Comply™ Adhesive Series 180C	PB	180/180C
3M™ Scotchcal™ Graphic Film 3662-10	PB	3662
3M™ Controltac™ Graphic Film with (or without) Comply™ Adhesive IJ160, IJ160C, all versions	PB	PIJ160/160C
3M™ Controltac™ Graphic Film with (or without) Comply™ Adhesive IJ180, IJ180C, IJ180Cv2, all versions	PB	PIJ180/180C
3M™ Controltac™ Changeable Graphic Film with Comply™ Adhesive IJ3552C (all versions)	PB	PIJ3552C
3M™ Scotchcal™ Changeable Graphic Film IJ3555 (all versions)	PB	PIJ3555
3M™ Scotchcal™ Graphic Film for Textured Surfaces IJ8624, FN8624, RG8624, 8624 ES	PB	8624
3M™ Controltac™ Conformable Graphic Film with Comply™ Adhesive 8620C ES	PB	8620C
3M™ Controltac™ Changeable Graphic Film with Comply™ Adhesive 8652C ES	PB	8652C
3M™ Controltac™ Changeable Graphic Film with Comply™ Adhesive 8655C ES	PB	8655C
3M™ Scotchcal™ Graphic Film 8662 ES	PB	8662
3M™ Scotchcal™ Luster Overlaminates 8524	PB	8524
Application, substrate selection, preparation and substrate-specific application techniques	IB	5.1
Storage, handling, maintenance, removal	IB	6.5
3M Graphics Center Warranty Brochure	go to www.3Mgraphics.com , Warranties	

3M, Scotch and ScotchBrite are trademarks of 3M Company.

Kliz is a trademark of Masterchem Industries Inc.; Sherwin-Williams is a trademark of Sherwin Williams Company; Pittsburgh is a registered trademark of PPG Industries, Inc.

Bulletin Change Summary

Added information about 3M™ Two-Handled Textured Surface Applicator TSA-4. Add a restriction about not applying film to loose sand-textured substrates.



Commercial Graphics Division
 3M Center, Building 220-12E-04
 PO Box 33220
 St. Paul, MN 55144-3220 USA
 General Info. 1-800-374-6772
 Technical Info. 1-800-328-3908
 Fax 1-651-736-4233

3M Canada
 P.O. Box 5757
 London, Ontario
 Canada N6A 4T1
 1-800-265-1840
 Fax 519-452-6245

3M México, S.A. de C.V
 Av. Santa Fe No. 55
 Col. Santa Fe, Del. Alvaro Obregón
 México, D.F. 01210
 52-55-52-70-04-00
 Fax 52-55-52-70-22-77

3M Puerto Rico, Inc.
 Puerto Rico Industrial Park
 P.O. Box 100
 Carolina, PR 00986-0100
 787-620-3000
 Fax 787-750-3035

www.3Mgraphics.com

©3M 2008. All rights reserved.